

David Jones

TIC Retail Accessories

**Garment Hanger
Ordering Manual**

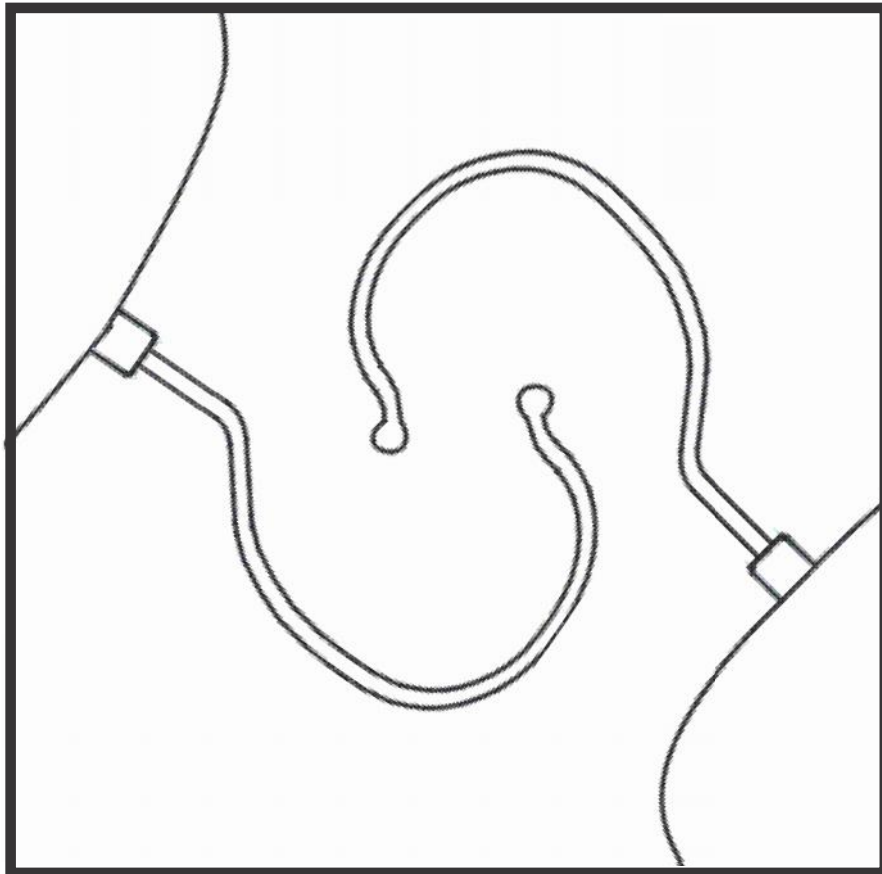

Retail Accessories

1. Ordering

Suppliers must place orders by accessing the TIC website and following the prompts. To use the online ordering system, suppliers must be registered with TIC, and issued with a password. All orders placed online will be automatically confirmed by return email. It is a David Jones requirement, that when placing orders, Suppliers are to nominate the volume required by David Jones. **All orders will be rounded up to the nearest full carton.**

1.1 Australia, New Zealand, Fiji, and Pacific Basin.

Orders can only be placed on-line by logging on to www.ticgroup.com.au click onto Retail Accessories and follow the prompts. All orders placed online will be automatically confirmed by return email.

Lead Times – all orders will be processed and dispatched within 2 working days.

Upon receipt of this package it is advised that Australian manufacturers and Australian based importers need to apply to TIC for a credit application form.

1.2 China, other Asian and European countries

Orders should be placed on – line by logging on to www.ticgroupasia.com click onto Retail Accessories and follow the prompts. All orders placed online will be automatically confirmed by return email.

Lead Times: On receipt of all approved Customs documentation from the customs office, orders will be processed for dispatch **within 3 working days.**

Important Note for China only: Chinese Customs Documentation supporting the export of these hangers, must supplied to TIC before orders can be processed.

2. CUSTOMS

2.1 Australia and New Zealand Customs Requirements:

Importers should ensure that the hanger cost is shown separately on Import Invoices and as a separate entry on the Import Duty Warrant under tariff item 3924-90-00 at 5% duty. All apparel merchandise invoices must include a declaration as per the following example:

Example:

“The unit cost of hangers, of Chinese origin, included on order 1234567 is US\$0.15 each and this cost is included in the invoice cost per unit of the product.”

If you have any queries, please contact the TIC (Retail Accessories) office.

2.2 China

Upon receipt of orders at TIC, a fax, accompanied by a telephone call is made to Suppliers, requesting a copy of their Customs Documentation.

From receipt of all Customs documentation goods are dispatched within 3 working days.

2.3 Other countries

For hangers imported into other countries it is the responsibility of the Importer to ensure correct customs procedures are followed.

3. Payment Terms

3.1 Australian and New Zealand Suppliers/Importers

Suppliers who do not have a credit facility with TIC will be required to pay for goods prior to delivery. ie. Payment Pre Delivery (PPD).

For a Trading Account / Credit. Suppliers must complete the Supplier Registration Form and submit to TIC (Refer to Appendix A.) If credit is approved by TIC, terms of payment are 30 days from invoice.

Subject to approval by TIC, where an Australian based importer requires delivery to their overseas manufacturer, the Australian based importer may receive trading terms of 30 days from invoice.

3.2 Other Overseas Agents and Manufacturers

Overseas Agents and Manufacturers who supply David Jones Importers will receive goods on a PPD (payment pre delivery) bases, unless previous Application for Credit has been approved.

Note: If outstanding invoices are not paid within 30 days from date of invoice, no further deliveries will be made.

When making payment – a remittance advice with full payment details is required.

Suppliers please note that TIC banking details are clearly displayed on all TIC invoices.

4. TIC GROUP CONTACT INFORMATION

TIC Group – Melbourne Office (Head Office)

214 Blackshaws Road
Altona North VIC Australia 3025
Telephone: (03) 9393 3737
Toll Free: 1800 790 110
Facsimile Number: (03) 9392 2332
Email: hangers@ticgroup.com.au
Web: www.ticgroup.com.au

All deliveries are ex TIC Melbourne National Warehouse.
All invoices will be issued in AUD\$ currency.

TIC Group – Hong Kong Office

Unit 3, 29/F Saxon Tower,
7 Cheung Shun Street,
Lai Chi Kok, KOWLOON,
HONG KONG
Telephone: (852) 2148 3685
Facsimile Number: (852) 2148 3085
Email: hangers.hk@ticgroupasia.com
Web: www.ticgroupasia.com

TIC Group–Ningbo Office (Represented by Ningbo Xunxing Trade Co Ltd)

Block 3, No 15 Chuang Ye Da Dao
West District of Free Trade Zone, Beilun
Ningbo, China
Telephone: 86 574 2687 3733
Facsimile Number: 86 574 8682 3880
Email: hangers.cn@ticgroupasia.com
Web: www.ticgroupasia.com

TIC Group–Shanghai Office

Unit E, 17/Floor, Hengji Plaza
No 99 East Huaihai Road
Huangpu District
Shanghai, 200021, China
Telephone: 86 21 6386 0808
Facsimile Number: 86 21 6386 9533
Email: hangers.cn@ticgroupasia.com
Web: www.ticgroupasia.com

All invoices will be issued in US\$ currency.

TIC (Retail Accessories) Pty Ltd.

232 Blackshaws Road, Victoria, Australia 3025

Phone: 613 9393 3737

Fax: 613 9392 2332

Email: hangers@ticgroup.com.au

ABN: 31 007 422 291



REGISTRATION FOR AUSTRALIAN, NEW ZEALAND BASED AND PACIFIC RIM MANUFACTURERS AND IMPORTERS

If granted a trading account(s) the Applicant agrees to conduct this/these account(s) within TIC (Retail Accessories) Pty Ltd. trading terms as they apply from time to time.

TRADING DETAILS:

ABN:

Trading Name:.....

Trading Address:.....

.....Postcode/Zip Code:.....

Phone:.....Fax:.....

Email:

IF SOLE TRADER/PARTNERSHIP (Complete this Section)

Owner's Name:.....

Private Address:.....

Phone:.....Date of Birth:.....Drivers Licence Number:.....

Owner's Name:.....

Private Address:.....

Phone:.....Date of Birth:.....Drivers Licence Number:.....

IF A COMPANY (Complete this Section)

Company

Name:.....

Registered

Address:.....

.....**Phone:**.....

Business License Number:.....

DETAILS OF DIRECTORS:

Name:.....

Private

Address:.....

Phone:.....

Name:.....

Private

Address:.....

Phone:.....

Name:.....

Private

Address:.....

Phone:.....

BANK DETAILS:

Bank:.....**Branch:**.....

Account Name:.....

Account Number:.....

Monthly Credit Applied For:.....

Anticipated Annual Spend A\$:.....

BUSINESS REFERENCES:

Name:.....

Address:.....

Phone:..... **Fax:**.....

Monthly Spend A\$.....

Name:.....

Address:.....

Phone:..... **Fax:**.....

Monthly Spend A\$.....

Name:.....

Address:.....

Phone:..... **Fax:**.....

Monthly Spend A\$.....

PLEASE READ CAREFULLY BEFORE SIGNING

I/We the undersigned hereby request that TIC (Retail Accessories) supply goods to me in consideration of TIC (Retail Accessories) agreeing to do so. I/We hereby jointly and severally warrant to and covenant with TIC (Retail Accessories) as follows;

1. That all information contained herein is true and correct in every particular and that all material facts have been disclosed to TIC (Retail Accessories).
2. That payments for all goods supplied by TIC (Retail Accessories) will be made strictly in accordance with the trading terms applicable from time to time.
3. If the applicant is a company then provision of a trading account pursuant to this application is subject to and conditional upon the applicant's directors executing a Guarantee in the form approved.
4. The undersigned and any director or principal of the applicant have never been made bankrupt and are solvent and are able to pay their debts as they fall due and have not made any compromise or arrangement with their creditors and no application has been made or proposed to a summon meeting of their creditors or any class of them.
5. That the applicant (if a corporation) is solvent and able to pay its debts as they fall due and is not in liquidation or being wound up and no meeting has been called or resolution has been passed or order made for such purposes and no Receiver or Receiver Manager has been appointed in respect of the applicant and the applicant has not made any compromise or arrangement with its creditors or any class of them and no application has been proposed or made to any court for an order summoning a meeting of its creditors or any class of them.
6. That the applicant hereby acknowledges receipt for TIC (Retail Accessories) Terms of Trade, as they presently exist.

Dated the:..... day of.....20.....

SOLE TRADER (SIGNATURE):.....

PARTNERS (SIGNATURE):.....

THE COMMON SEAL of)
was hereunto affixed)
in accordance with its Articles of)
Association in the presence of)

.....Director

.....Secretary

TIC (Retail Accessories) Pty Ltd.
232 Blackshaws Road, Altona North, Victoria, Australia 3025

Your Authorised TIC Webpage Password

IN CONSIDERATION of you having agreed or agreeing to sell goods or provide services or extend credit to the party named in the Schedule hereto as the debtor (herein after called "the debtor" we, the parties named in the Schedule hereto as he Guarantors JOINTLY AND SEVERALLY GUARANTEE the due and punctual payment to you by the debtor of all monies now and hereafter payable to the debtor to you on any account whatsoever whether such sale, provision or extension shall have occurred or been made before or after the execution of this instrument and whether or not the said agreement to sell goods, provide services or extend credit, may be or become void or voidable or unenforceable by law. WE JOINTLY AND SEVERALLY INDEMINIFY you against all loss and damage suffered by you by reason of a failure of the debtor duly to perform any obligation on its part arising out of or in connection with such sale, provision or extension AND WE EXPRESSLY ACKNOWLEDGE AND DECLARE that this Guarantee is given upon the following conditions:

1. The certificate of your Secretary, Credit Manager or Solicitors for the time being stating the amount or amounts due and owing to you by the debtor in relation to such sale, provision or extension shall be conclusive evidence of the indebtedness of the debtor to you as the date stated in such certificate.
2. Our liability to you hereafter shall not be affected by time or any other indulgence granted to you by the debtor or by modification or variation in the terms of sale, provision or extension. You may at such time as you think fit cease to sell goods to or provide services for or extend credit to the debtor.
3. The guarantee hereby given shall be a continuing guarantee and shall bind our executors and administrators.
4. Any demand on us hereunder may be duly made if it is in writing signed by your Secretary, Credit Manager or Solicitors and is given to or left for us at or posted to one of our addresses set out as below or to such other addresses as we may from time to time notify you in writing, PROVIDED THAT it shall not be a condition precedent to the exercise of your rights against us hereunder that any demand or notice will be given to us.
5. Except where the context forbids words herein importing the plural shall include the singular and vice versa.
6. Until you have received 100 cents in the dollar in respect of the Guarantee obligations the Guarantor shall not be entitled either directly or indirectly receive the benefit from the administration of the affairs of the debtor in insolvency resulting from the lodging of any proof or make nay claim in respect thereof in competition with you so as to diminish any amount that but for such dividend or other payment that you may receive shall not prejudice your right to recover so much of the guaranteed amounts as have not been paid to you.
7. No monies received by you to the creditor of the debtor and for which you may in any administration in insolvency of the affairs as the debtor be obliged to account to any liquidator, official manager, trustee in bankruptcy may in your discretion be received by you discharge or diminish our liability hereunder.

Conditions of Sale

Interpretation

1. In these conditions:
‘Seller’ means [Tic (Retail Accessories) Pty Ltd] which is the seller of the goods.
‘Buyer’ means the purchaser of the goods specified overleaf.
‘Goods’ means the products and, if any, services specified overleaf.
Nothing in these conditions shall be read or applied so as to exclude, restrict or modify or have the effect of excluding, restricting or modifying any condition, warranty, guarantee, right or remedy implied by law (including the Trade Practices Act 1974) and which by law cannot be excluded, restricted or modified.

General

2. These conditions (which shall only be waived in writing signed by the seller) shall prevail over all conditions of the buyer’s order to the extent of any inconsistency.

Important note: A number of garment hangers, accessories and supporting devices are the subject of Intellectual Property Rights owned by TIC Group Pty Ltd. and/or its affiliates. Any breach of these rights may be the subject of legal action.

Disclaimer: Suppliers have a duty of care to ensure hangers and accessories selected from the TIC range can withstand the particular transport, distribution and handling environments they will be subjected to. Please contact TIC if you require assistance with the selection of hangers or accessories.

Terms of sale

3. The goods and all other products sold by seller are sold on these terms and conditions.

Seller’s quotations

4. Unless previously withdrawn, seller’s quotations are open for acceptance within the period stated in them or, when no period is so stated, within 30 days only after its date. The seller reserves the right to refuse any order based on this quotation within 7 days after the receipt of the order.

Packing

5. The cost of any special packing and packing materials used in relation to the goods are at the buyer’s expense notwithstanding that such cost may have been omitted from any quotation.

Shortage

6. The buyer waives any claim for shortage of any goods delivered if a claim in respect for short delivery has not been lodged with the seller within seven (7) days from the date of receipt of goods by the buyer.

Delivery

7. (a) The delivery times made known to the buyer are estimates only and the seller is not be liable for late delivery or non-delivery.
(b) The seller is not be liable for any loss, damage or delay occasioned to the buyer or its customers arising from late or non-delivery or late installation of the goods.
(c) The seller may at its option deliver the goods to the buyer in any number of instalments unless there is an endorsement overleaf to the effect that the buyer will not take delivery by instalments.
(d) If the seller delivers any of the goods by instalments, and any one of those instalments is defective for any reason:
 - (1) it is not a repudiation of the contract of sale formed by these conditions; and
 - (2) the defective instalment is a severable breach that gives rise only to a claim for compensation.

Loss or damage in transit

8. (a) The seller is not responsible to the buyer or any person claiming through the buyer for any loss or damage to goods in transit caused by any event of any kind by any person (whether or not the seller is legally responsible for the person who caused or contributed to that loss or damage).
(b) The seller must provide the buyer with such assistance as may be necessary to press claims on carriers so long as the buyer:
 - (1) has notified the seller and the carriers in writing immediately after loss or damage is discovered on receipt of goods; and
 - (2) lodges a claim for compensation on the carrier within three (3) days of the date of receipt of the goods.

Prices

9. (a) Unless otherwise stated all prices quoted by the seller are net, exclusive of Goods and Services Tax (GST).
(b) Prices quoted are those ruling at the date of issue of quotation and are based on rates of freight, insurance, customs duties, exchange, shipping expenses, sorting and stacking charges, cartage, rate of wates, cost of materials and other charges affecting the cost of production ruling on the date is made.
(c) If the seller makes any alterations to the price of the goods or to any of their inputs either before acceptance of or during the currency of the contract, these alterations are for the buyer’s account.

Payment

10. The purchase price in relation to goods is payable net and payment of the price of the goods must be made on or before thirty days from date of the delivery of the goods unless other terms of payment are expressly stated in these conditions in writing.

Rights in relation to goods

11. The seller reserves the following rights in relation to the goods until all accounts owed by the buyer to the seller are fully paid:

- (1) ownership of the goods;
- (2) to enter the buyer’s premises (or the premises of any associated company or agent where the goods are located) without liability for trespass or any resulting damage and retake possession of the goods; and
- (3) to keep or resell any goods repossessed pursuant to (2) above.

If the goods are resold by the buyer, the buyer shall hold such part of the proceeds of any such sale as represents the invoice price of the goods sold in a separate identifiable account as the beneficial property of the seller and shall pay such amount to the seller upon request. Notwithstanding the provisions above the seller shall be entitled to maintain an action against the buyer for the purchase price and the risk of the goods shall pass to the buyer upon delivery.

Buyer’s property

12. Any property of the buyer under the seller’s possession, custody or control is completely at the buyer’s risk as regards loss or damage caused to the property or by it.

Storage

13. The seller reserves the right to make a reasonable charge for storage if delivery instructions are not provided by the buyer within fourteen days of a request by the seller for such instructions. The parties agree that the seller may charge for storage from the first day after the seller requests the buyer to provide delivery instructions.

Returned goods

- 14. (a) The seller is not be under any duty to accept goods returned by the buyer and will do so only on terms to be agreed in writing in each individual case.
- (b) If the seller agrees to accept returned goods from the buyer under para (a) of this clause, the buyer must return the goods to the seller at the seller’s place of business referred to at the head of these conditions.

Goods sold

15. All goods to be supplied by the seller to the buyer are as described on the purchase order agreed by the seller and the buyer and the description on such purchase order modified as so agreed prevails over all other descriptions including any specification or enquiry of the buyer.

Cancellation

16. No order may be cancelled except with consent in writing and on terms which will indemnify the seller against all losses.

Default

17. If the Buyer defaults in payment of any monies due to the Seller the Buyer shall at the option of the Seller pay to the Seller interest on the monies in respect of which default in payment has been made calculated at the daily rate being the rate prescribed from time to time pursuant to the Penalty Interest Rates Act 1983 plus 4% together with and in addition to all costs and expenses including legal costs on a solicitor/client basis incurred by the Seller in recovering from the Buyer monies due as a consequence of the default by the Buyer in payment of monies on the due date for payment.

Place of contract

- 18 (a) The contract for sale of the goods is made in the State of Victoria.
- (b) The parties submit all disputes arising between them to the courts of the State of Victoria and any court competent to hear appeals from those courts of first instance.

Signed _____ Position _____

Dated _____

TIC Group – Ningbo Office

(Represented by Ningbo Xunxing Trade Co Ltd)

Block 3, No 15, Chuang Ye Da Dao,

West District of Free Trade Zone, Beilun, Ningbo, China

Tel: +86 574 2687 3733

Fax: +86 574 8682 3880

Email: hangers.cn@ticgroupasia.com



REGISTRATION FOR CHINA, SOUTH EAST ASIA, INDIAN, MANUFACTURERS AND AGENTS

TRADING DETAILS:

ABN:

Trading Name:.....

Trading Address:.....

.....Postcode/Zip Code:.....

Phone:.....Fax:.....

Email:.....

COMPANY DETAILS (Complete this Section)

Company

Name:.....

Registered

Address:.....

.....**Phone:**.....

Business License Number:.....

DETAILS OF DIRECTORS:

Name:.....

Private

Address:.....

Phone:.....

Name:.....

Private

Address:.....

Phone:.....

BANK DETAILS:
Monthly Credit Applied For:.....
Anticipated Annual Spend:

Bank:.....**Branch:**.....
Account Name:.....
Account Number:.....

Monthly Credit Applied For:.....
Anticipated Annual Spend US\$:.....

PLEASE READ CAREFULLY BEFORE SIGNING

1. Credit will only be given to Anaconda’s suppliers that have been approved by Anaconda.
2. All other suppliers must pre-pay for their hangers and accessories.
3. TIC Group (Asia) reserves the right to withhold deliveries of hangers and accessories if the supplier has not pre-paid for their hangers and accessories.
4. TIC Group (Asia) reserves the right to withhold deliveries of hangers and accessories if a supplier granted credit has not settled outstanding invoices within 30 days of the invoice being issued.

Dated the:..... day of.....20.....

COMPANY CHOP HERE

TIC Group – Ningbo Office (Represented by Ningbo Xunxing Trade Co Ltd)
Block 3, No 15, Chuang Ye Da Dao, West District of Free Trade Zone, Beilun, Ningbo, China

Your Authorised TIC Webpage Password

Conditions of Sale

Interpretation

1. In these conditions:
‘Seller’ means TIC Group (Asia) Ltd. which is the seller of the goods.
‘Buyer’ means the purchaser of the goods specified overleaf.
‘Goods’ means the products and, if any, services specified overleaf.

General

2. These conditions (which shall only be waived in writing signed by the seller) shall prevail over all conditions of the buyer’s order to the extent of any inconsistency.

Important note: A number of garment hangers, accessories and supporting devices are the subject of Intellectual Property Rights owned by TIC Group Pty Ltd. and/or its affiliates. Any breach of these rights may be the subject of legal action.

Disclaimer: Suppliers have a duty of care to ensure hangers and accessories selected from the TIC range can withstand the particular transport, distribution and handling environments they will be subjected to. Please contact TIC if you require assistance with the selection of hangers or accessories.

Terms of sale

3. The goods and all other products sold by seller are sold on these terms and conditions.

Seller’s quotations

4. Unless previously withdrawn, seller’s quotations are open for acceptance within the period stated in them or, when no period is so stated, within 30 days only after its date. The seller reserves the right to refuse any order based on this quotation within 7 days after the receipt of the order.

Packing

5. The cost of any special packing and packing materials used in relation to the goods are at the buyer’s expense notwithstanding that such cost may have been omitted from any quotation.

Shortage

6. The buyer waives any claim for shortage of any goods delivered if a claim in respect for short delivery has not been lodged with the seller within seven (7) days from the date of receipt of goods by the buyer.

Delivery

7. (a) The delivery times made known to the buyer are estimates only and the seller will not be liable for late delivery or non-delivery.
(b) The seller will not be liable for any loss, damage or delay occasioned to the buyer or its customers arising from late or non-delivery or late installation of the goods.
(c) The seller may at its option deliver the goods to the buyer in any number of installments unless there is an endorsement overleaf to the effect that the buyer will not take delivery by installments.
(d) If the seller delivers any of the goods by installments, and any one of those installments is defective for any reason:
(1) it is not a repudiation of the contract of sale formed by these conditions; and
(2) the defective installment is a severable breach that gives rise only to a claim for compensation.

Loss or damage in transit

8. (a) The seller is not responsible to the buyer or any person claiming through the buyer for any loss or damage to goods in transit caused by any event of any kind by any person (whether or not the seller is legally responsible for the person who caused or contributed to that loss or damage).
(b) The seller must provide the buyer with such assistance as may be necessary to press claims on carriers so long as the buyer:
(1) has notified the seller and the carriers in writing immediately after loss or damage is discovered on receipt of goods; and
(2) lodges a claim for compensation on the carrier within three (3) days of the date of receipt of the goods.

Prices

9. (a) Prices quoted are those ruling at the date of issue of quotation and are based on rates of freight, insurance, customs duties, exchange, shipping expenses, sorting and stacking charges, cartage, rate of wastes, cost of materials and other charges affecting the cost of production ruling on the date is made.
(b) If the seller makes any alterations to the price of the goods or to any of their inputs either before acceptance of or during the currency of the contract, these alterations are for the buyer’s account.

Payment

10. The purchase price in relation to goods is payable net and payment of the price of the goods must be made on or before thirty days from date of the delivery of the goods unless other terms of payment are expressly stated in these conditions in writing.

Rights in relation to goods

11. The seller reserves the following rights in relation to the goods until all accounts owed by the buyer to the seller are fully paid:

- (1) ownership of the goods;
- (2) to enter the buyer's premises (or the premises of any associated company or agent where the goods are located) without liability for trespass or any resulting damage and retake possession of the goods; and
- (3) to keep or resell any goods repossessed pursuant to (2) above.

If the goods are resold by the buyer, the buyer shall hold such part of the proceeds of any such sale as represents the invoice price of the goods sold in a separate identifiable account as the beneficial property of the seller and shall pay such amount to the seller upon request. Notwithstanding the provisions above the seller shall be entitled to maintain an action against the buyer for the purchase price and the risk of the goods shall pass to the buyer upon delivery.

Buyer's property

12. Any property of the buyer under the seller's possession, custody or control is completely at the buyer's risk as regards loss or damage caused to the property or by it.

Storage

13. The seller reserves the right to make a reasonable charge for storage if delivery instructions are not provided by the buyer within fourteen days of a request by the seller for such instructions. The parties agree that the seller may charge for storage from the first day after the seller requests the buyer to provide delivery instructions.

Returned goods

14. (a) The seller is not under any duty to accept goods returned by the buyer and will do so only on terms to be agreed in writing in each individual case.
- (b) If the seller agrees to accept returned goods from the buyer under paragraph (a) of this clause, the buyer must return the goods to the seller at the seller's place of business referred to at the head of these conditions.

Goods sold

15. All goods to be supplied by the seller to the buyer are as described on the purchase order agreed by the seller and the buyer and the description on such purchase order modified as so agreed prevails over all other descriptions including any specification or enquiry of the buyer.

Cancellation

16. No order may be cancelled except with consent in writing and on terms which will indemnify the seller against all losses.

Signed _____ Position _____

Dated _____



**TIC GROUP LTD GARMENT HANGERS
PRE - APPROVED BY DAVID JONES**

HANGER INDEX

Category	Code	Colour	
Tops	4466WDJ 4471WDJ 4467WDJ 4468WDJ 4455DJ 4456DJ 4470SDJ 4470DJ 4489DJ 4475DJ	White White White White Black Black Black Black Black Black	250 mm Children's Upper Body 300 mm Children's Upper Body 360 mm Children's Upper Body 410 mm Adult's Upper Body 410 mm Adult's Upper Body 460 mm Adult's Upper Body 410 mm Adult's Knitwear 460 mm Adult's Knitwear 430 mm Adult's Jacket 460 mm Adult's Jacket
Bottoms	4433LCDJ 4427WDJ 4472DJ 4472WDJ 4473DJ 4473WDJ 4429DJ	Clear White Black White Black White Black	300 mm Adult's Lower Body 190 mm Children's Bottom Body 280 mm Children's Bottom Body 280 mm Children's Bottom Body 320 mm Adult's Bottom Body 320 mm Adult's Bottom Body 360 mm Adult's Bottom Body
Sleepwear	4495CDJ 4496CDJ	Clear Clear	410 mm Adult's Sleepwear 460 mm Adult's Sleepwear
Lingerie	4437CDJ 4436CDJ	Clear Clear	210mm Lingerie Hanger 260mm Lingerie Hanger
Access.	4402CL/1 4402DJ/1 4402CDJ/1	Clear Black Clear	Hook & Loop Hook & Loop Hook & Loop
Price List			

Category • Children

Application • Shirts, Tops, Dresses, Knitwear, Jackets,
Jump Suits, Overalls, Sleepwear, Spencers, Camisoles and Slips

C O D E

4466WDJ

4471WDJ

4468WDJ

4467WDJ

Top
White Hanger

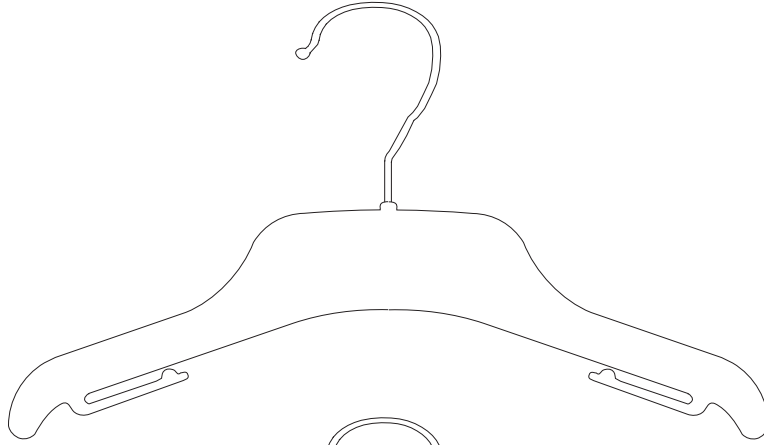

4466WDJ
250mm

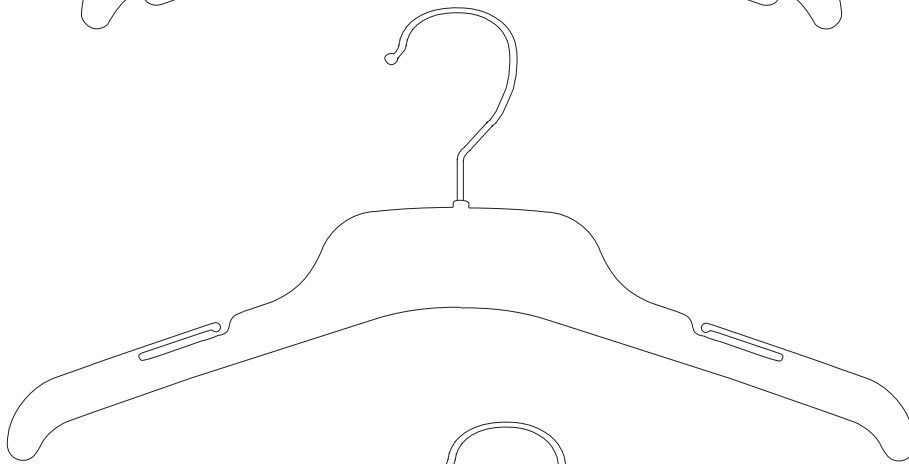

4471WDJ
300mm

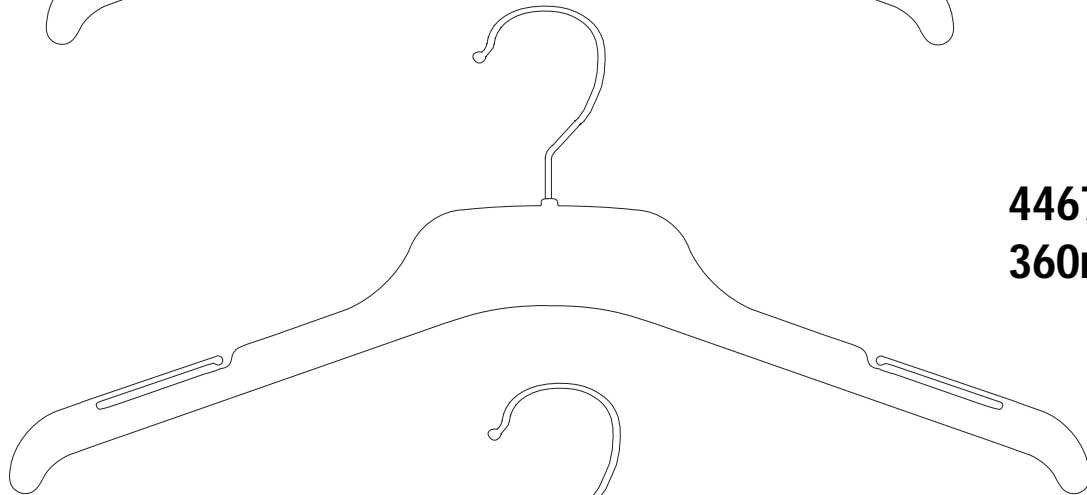

4467WDJ
360mm

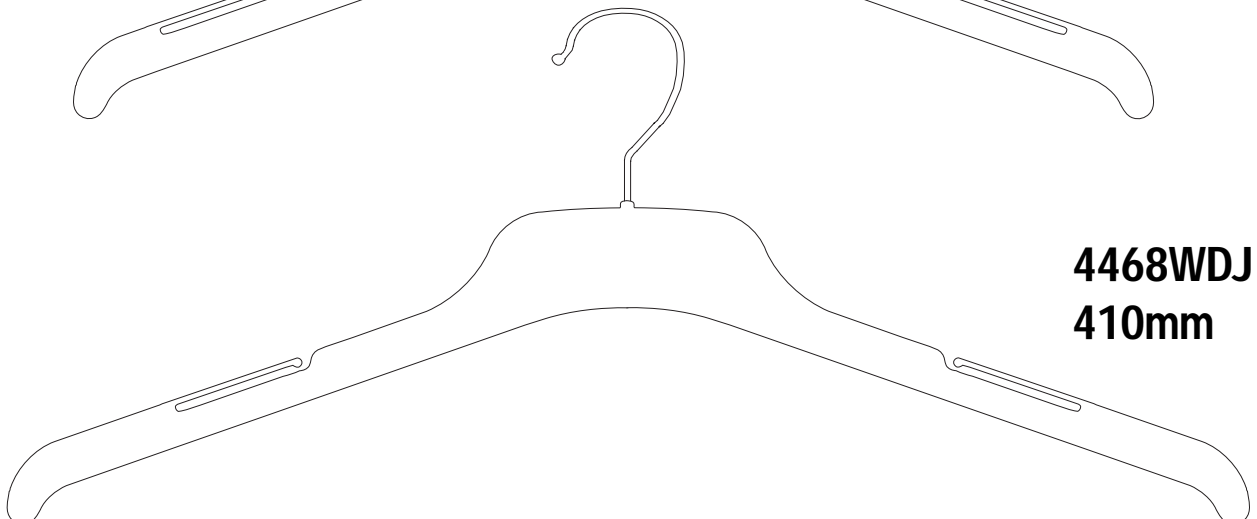

4468WDJ
410mm

C O D E

Category • Adults

Application • Shirts, Tops (assorted), Dresses,
Knitwear, Jackets

4455DJ

4456DJ

Top Hangers

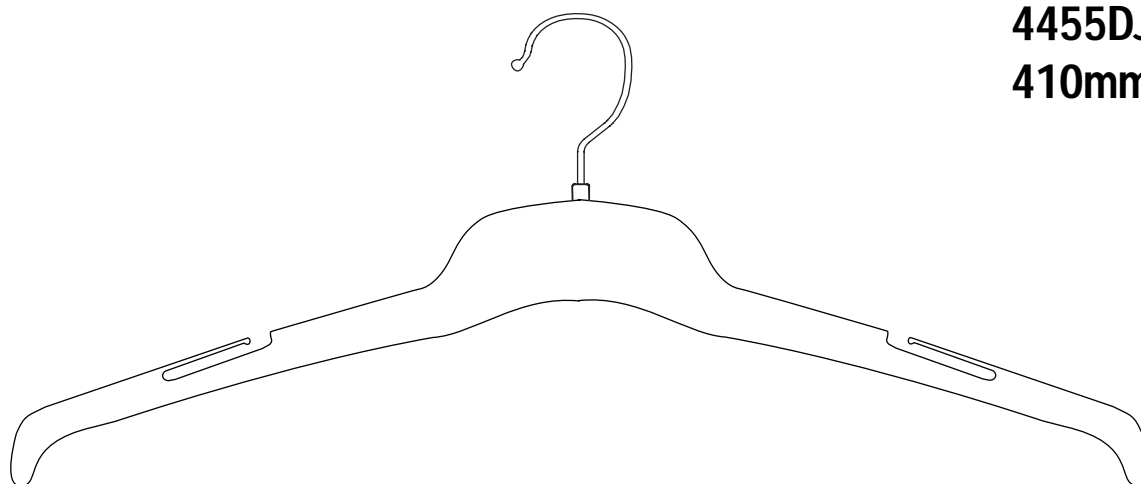

4455DJ
410mm

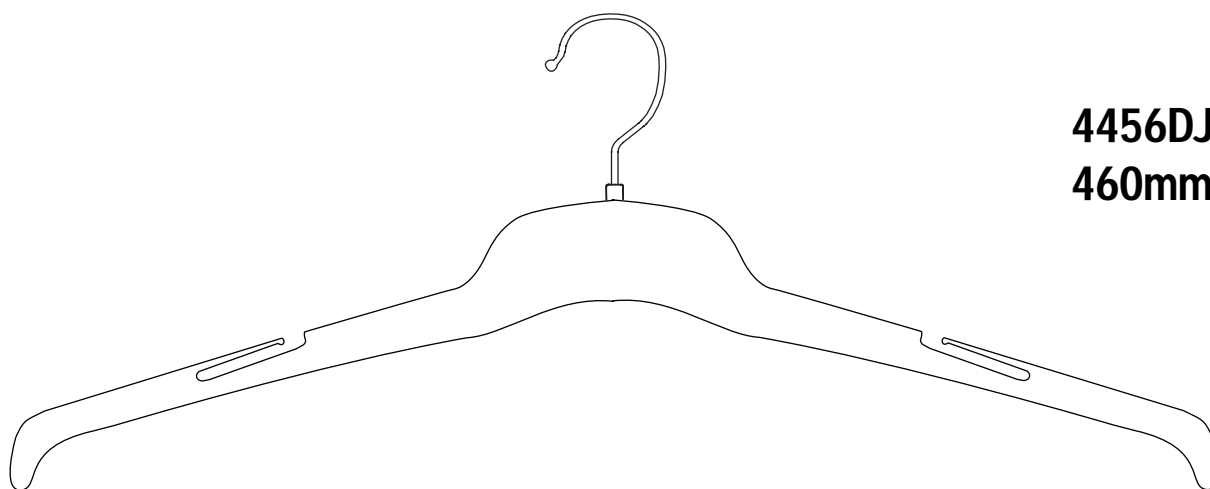

4456DJ
460mm

Category • Adults

Application • Jackets

C O D E

4489DJ

4475DJ

Jacket Hangers

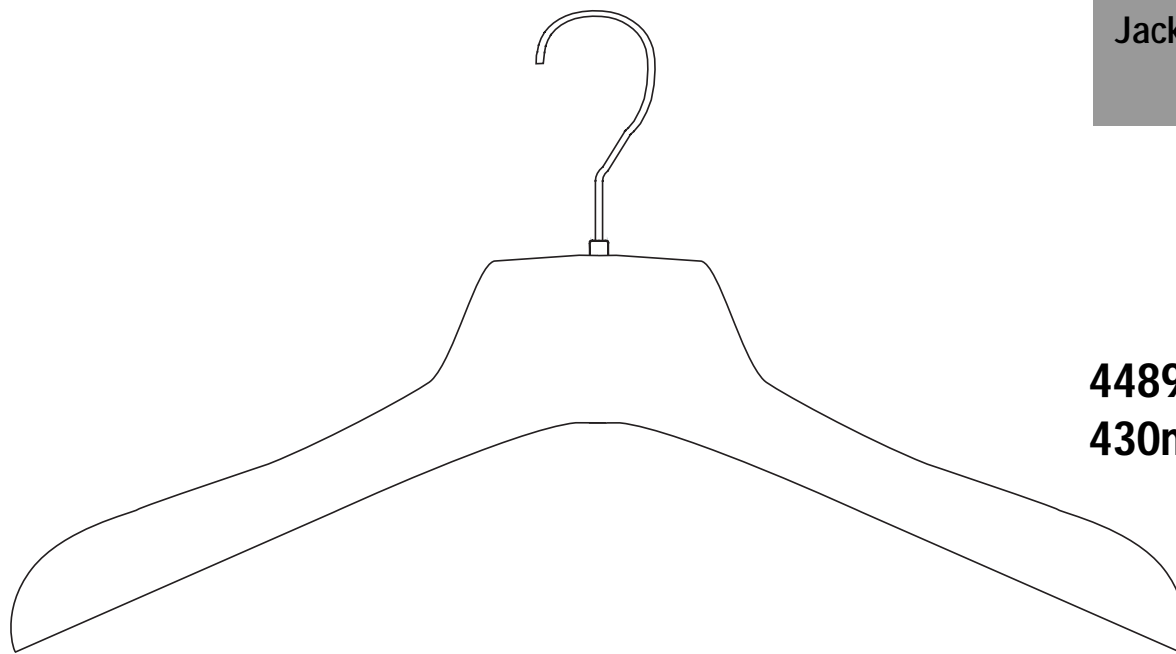

4489DJ
430mm

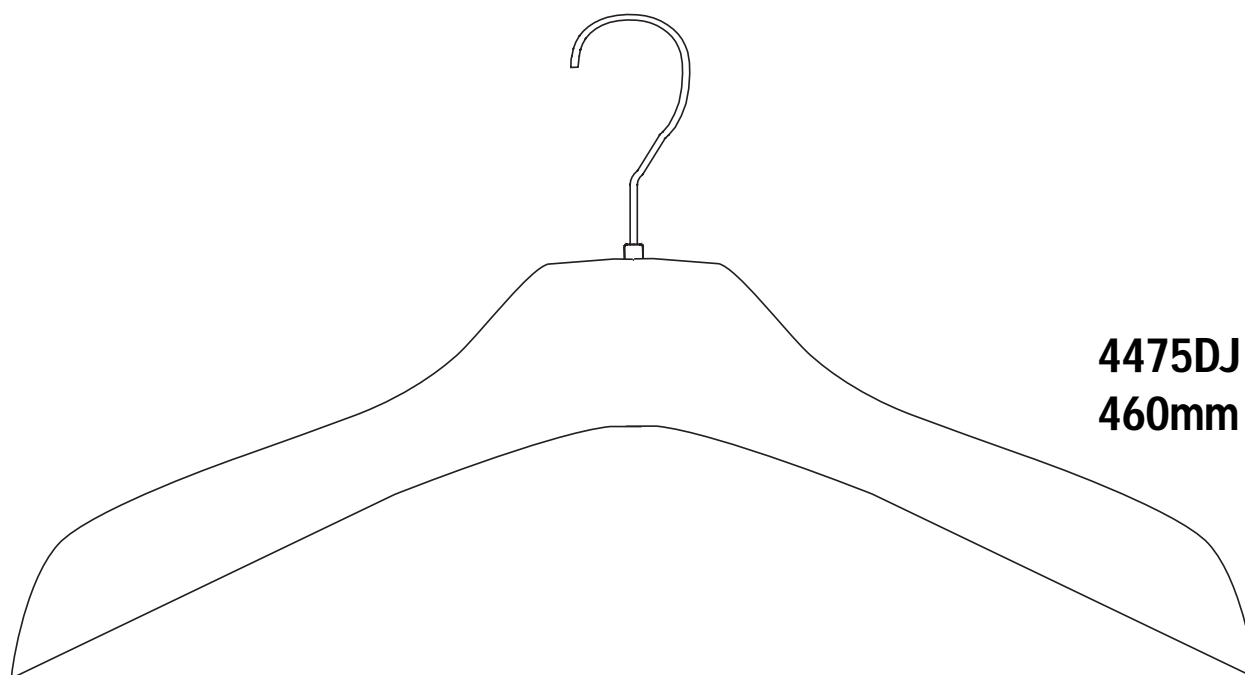

4475DJ
460mm

Category • Adult

Application • Knitwear

C O D E

4470SDJ

4470DJ

Top Knitwear
Hangers

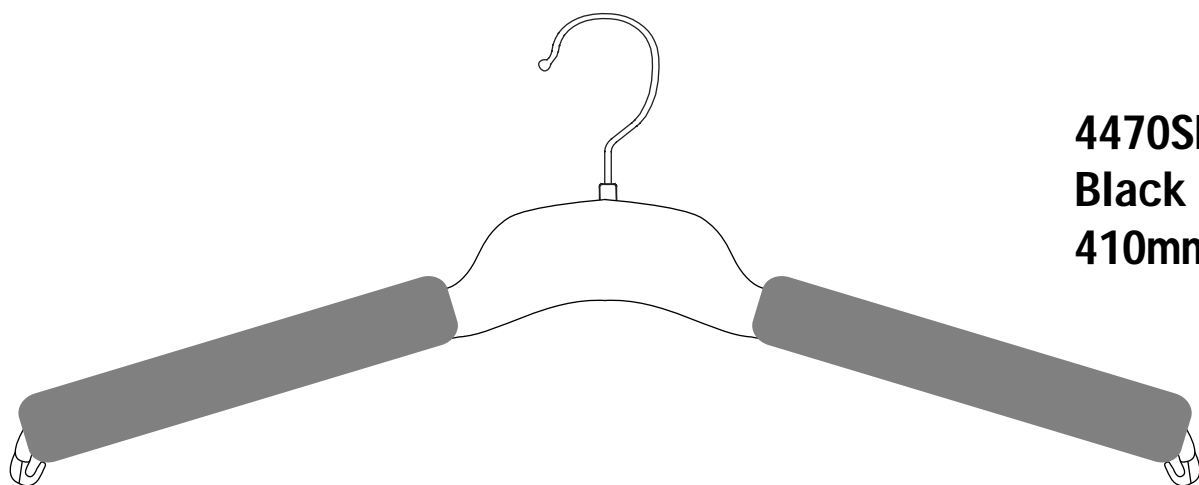

4470SDJ
Black
410mm

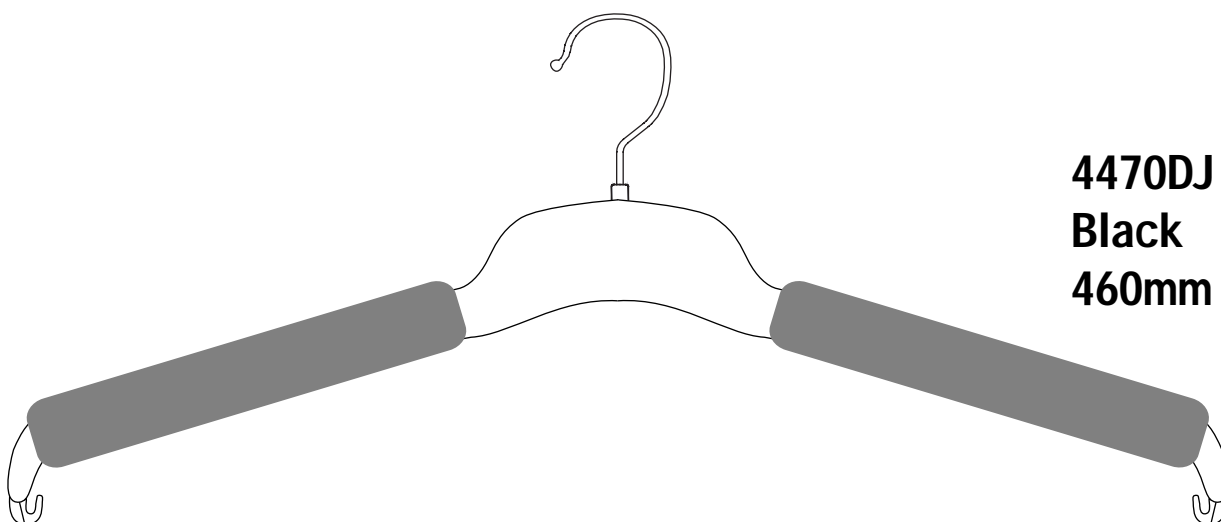

4470DJ
Black
460mm

C O D E

Category • Adults and Childrenswear

Application • Pants, Skirts, Shorts and Sets

4472DJ
4473DJ

Bottom Hanger
Low Profile

4472DJ
Black
280mm

4472WDJ
White
280mm

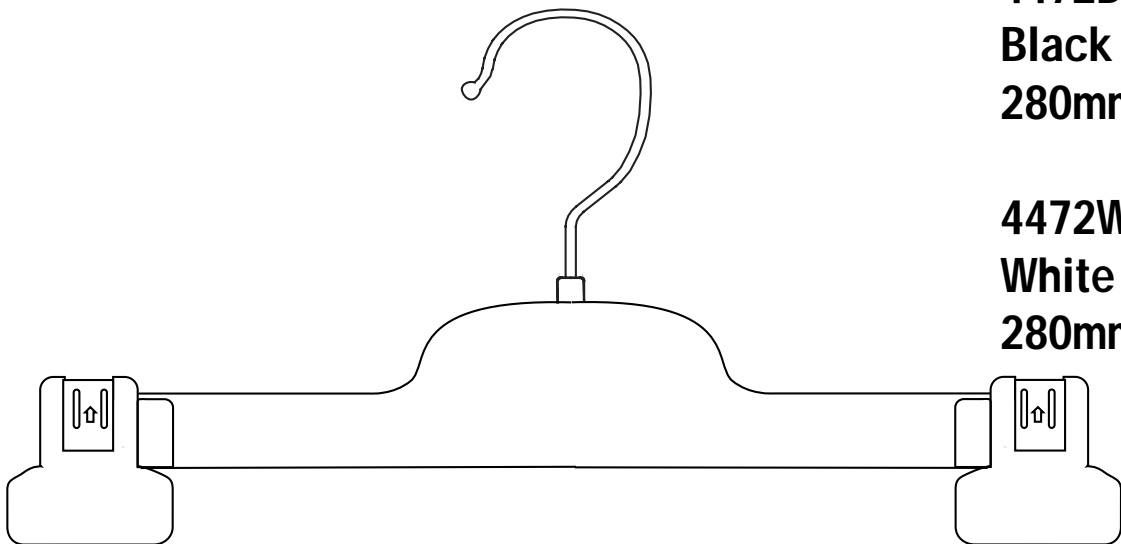

4473DJ
Black
320mm

4473WDJ
White
320mm

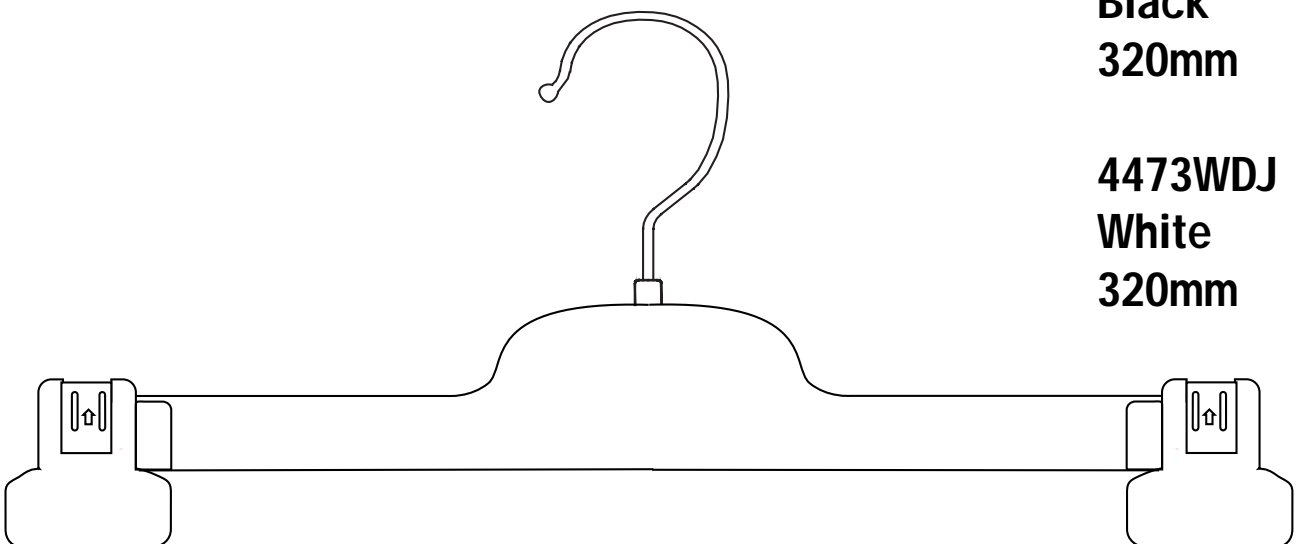

C O D E

Category • Adult

Application • Pants, Skirts, Shorts and Sets

4429DJ

Bottom
Movable Clip
Hanger

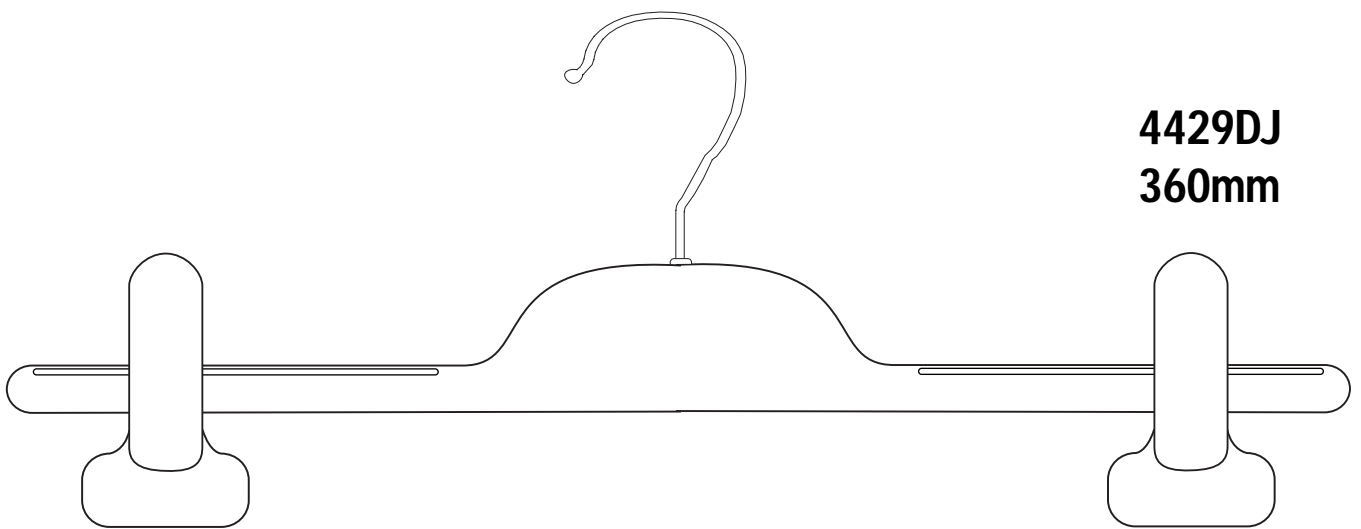

4429DJ
360mm

C O D E

Category • Adults

Application • Pants, Skirts, Shorts and Sets

4433LCDJ

Bottom
Hanger
Low Profile

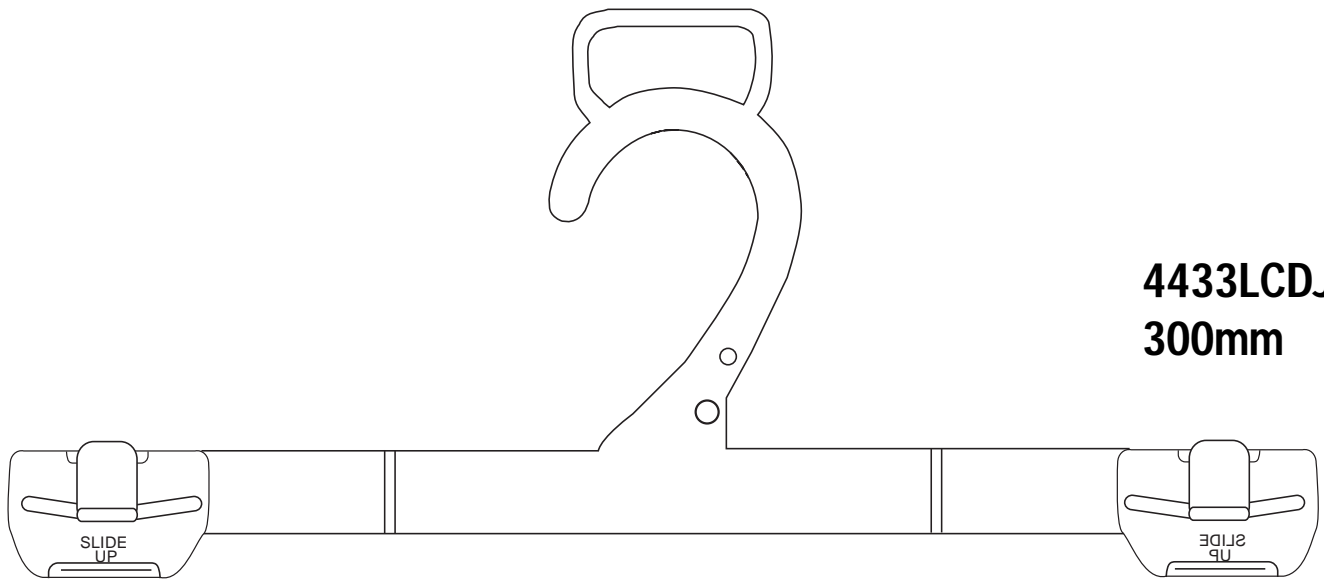

4433LCDJ
300mm

Category • Childrens

Application • Pants, Skirts, Shorts and Sets

C O D E

4427WDJ

Bottom Hanger

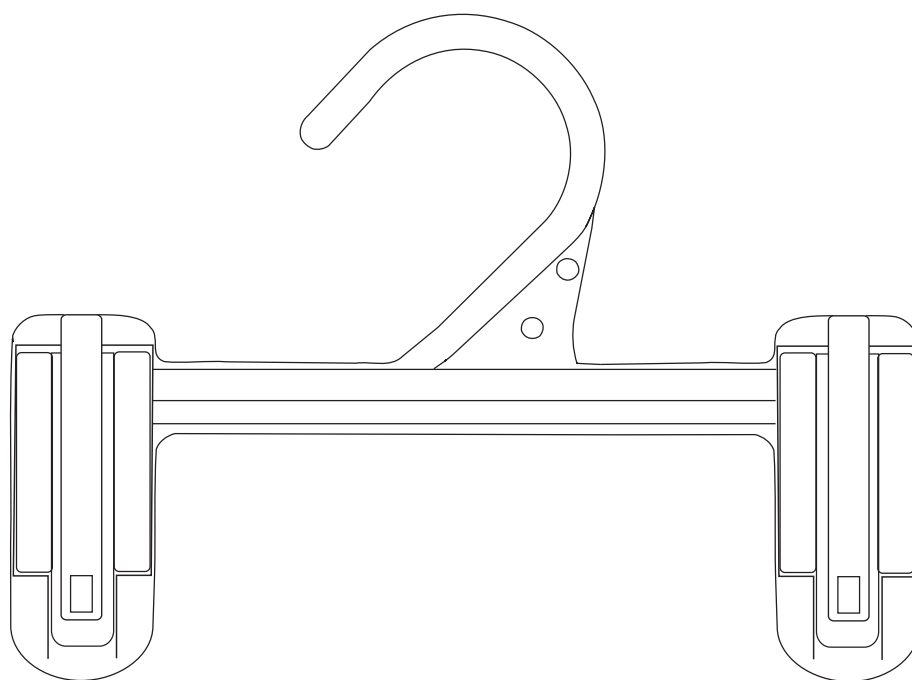

4427WDJ
190mm

Category • Adult

Application • Sleepwear

C O D E

4495CDJ

4496CDJ

Top Clear
Hanger

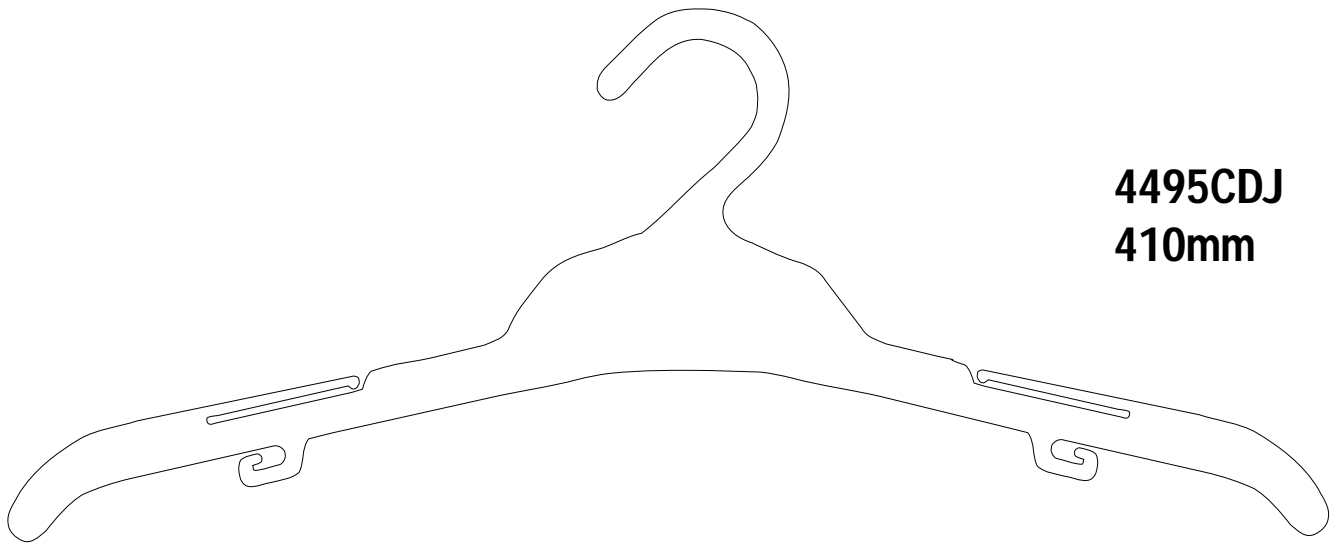

4495CDJ
410mm

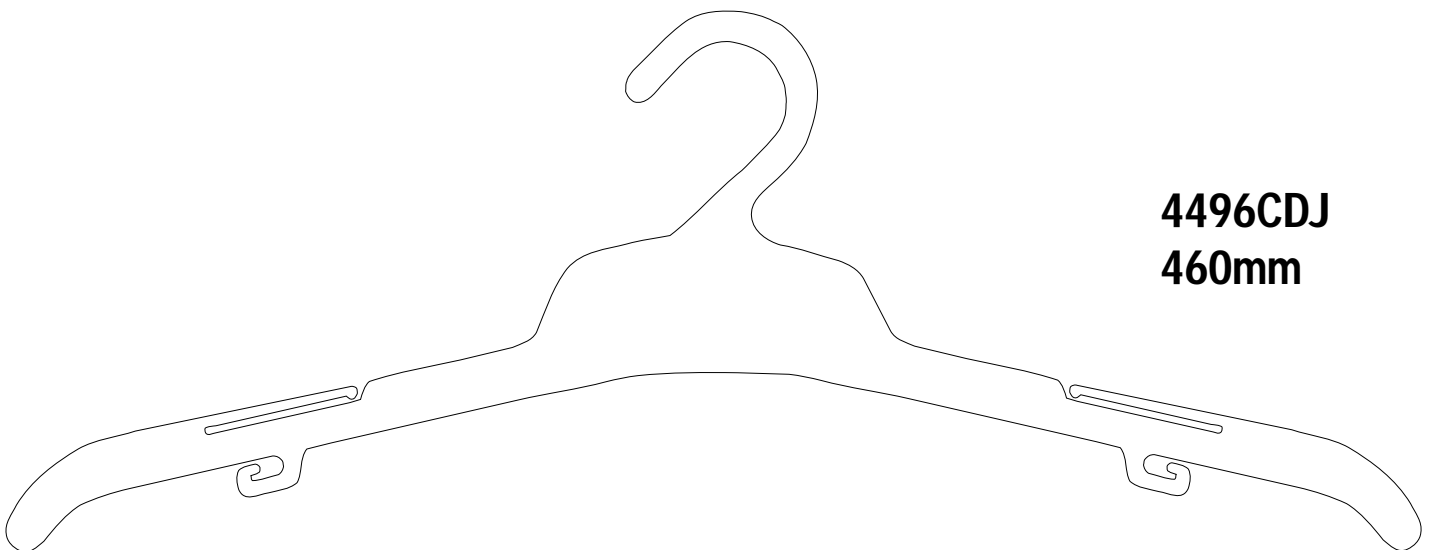

4496CDJ
460mm

C O D E

Category • Children and Adults

Application • Briefs, Bras, Camisoles and Underwear Sets

4437CDJ
4436CDJ

**Adult &
Childrens Brief
and Lingerie
Hanger**

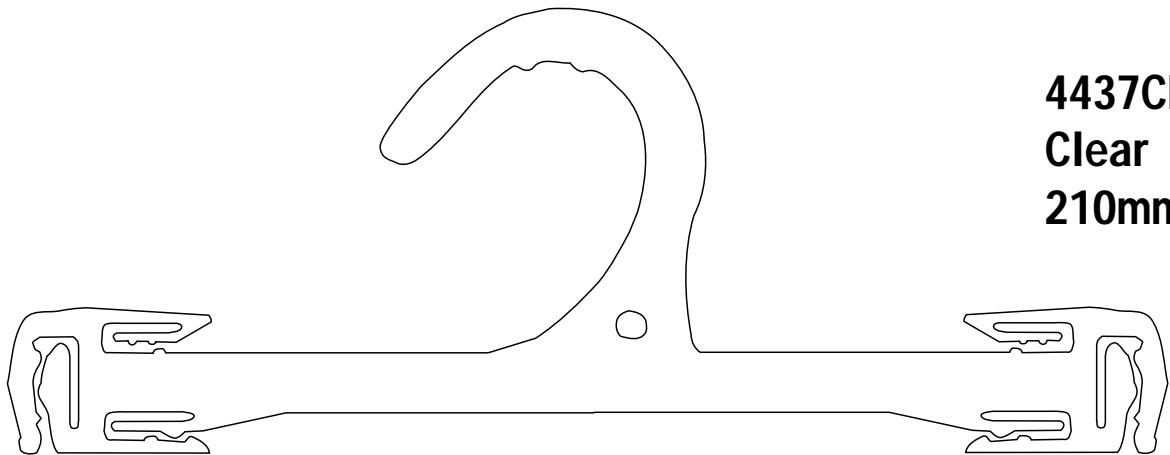

4437CDJ
Clear
210mm

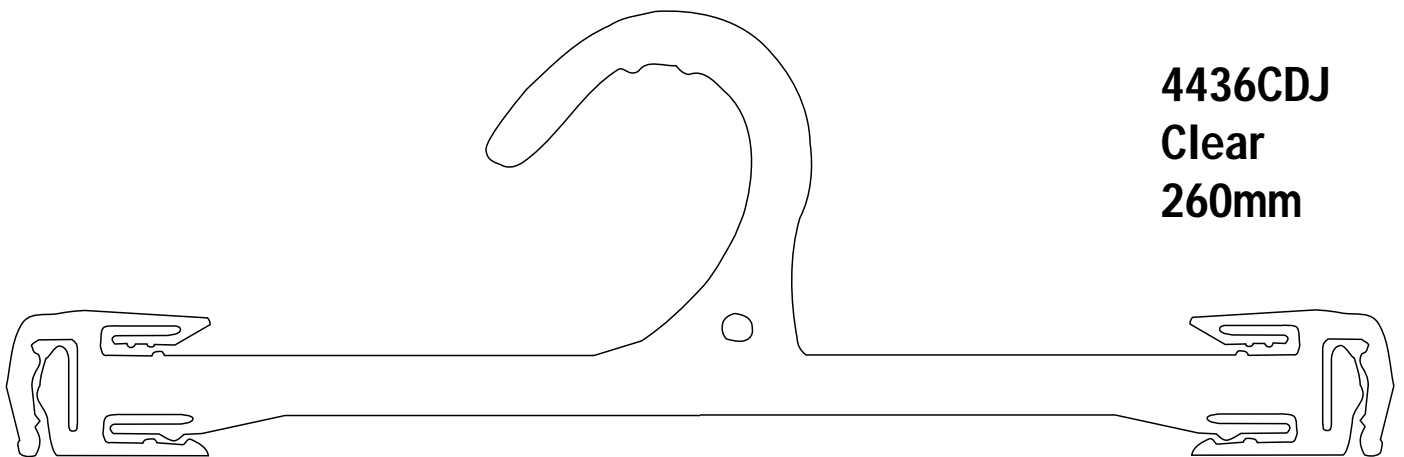

4436CDJ
Clear
260mm

C O D E

Category • Children and Adults

Application • Totally interchangeable for
all top and bottom hangers
and universal accessory hook

AC69CR
4402CL/1
4402DJ/1
CL4418BL

Hook and Loop
Universal
Accessory Hook

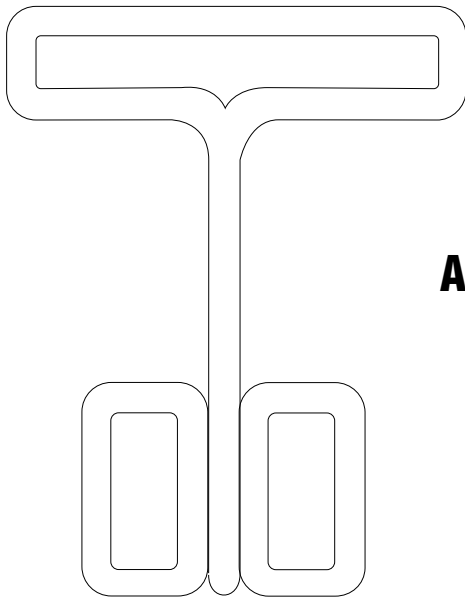

AC69CR

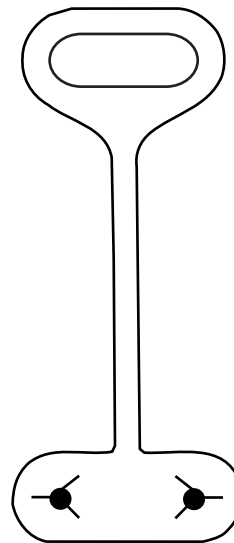

4402DJ/1
4402CDJ/1



CL4418BL